

1 1

1 1 1 1

2 2

2 2 2 2

3 3

3 3 3 3

4 4

4 4 4 4

NOMBRE:

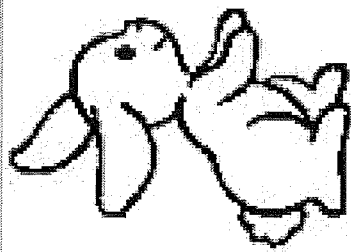

1 CONEJO

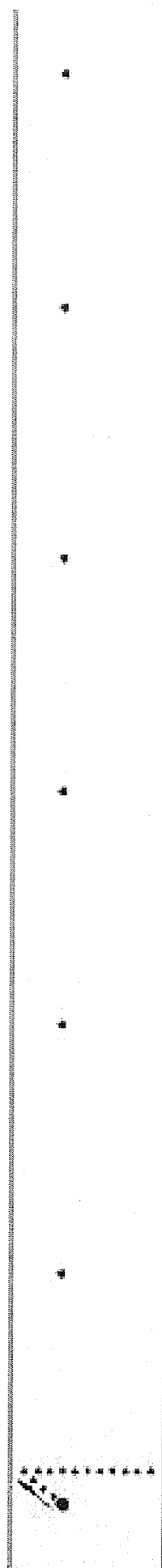
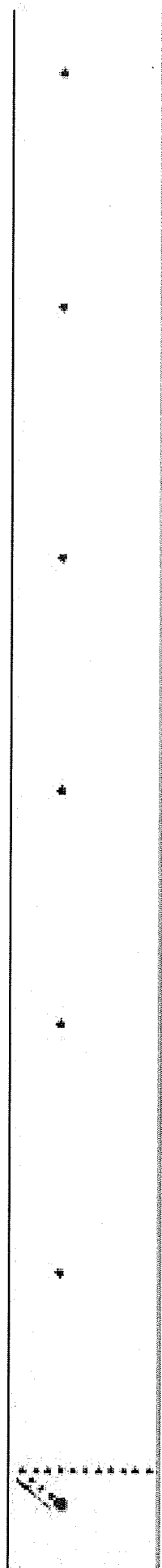
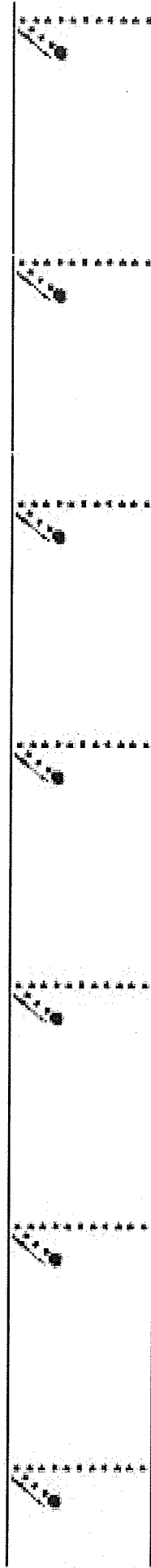

NOMBRE:

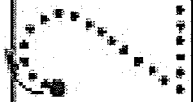

NOMBRE:



3 CONEJOS



NOMBRE:

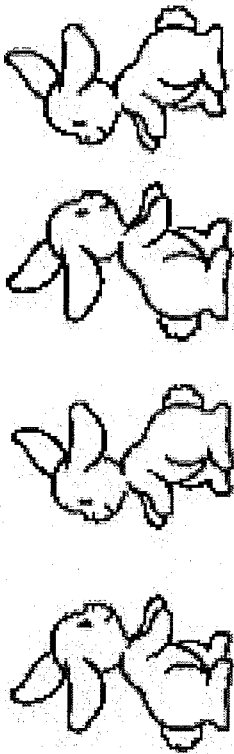

4 CONEJOS

Four sets of horizontal writing lines, each consisting of a solid top line, a dashed middle line, and a solid bottom line, for practicing handwriting.

NOMBRE:

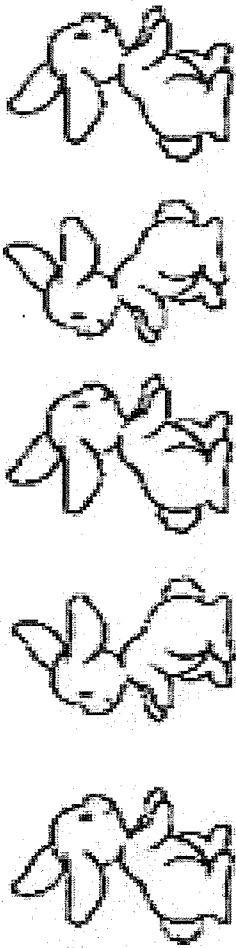

5 CONEJOS



NOMBRE:



6 CONEJOS

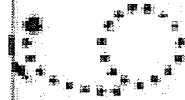

NOMBRE:

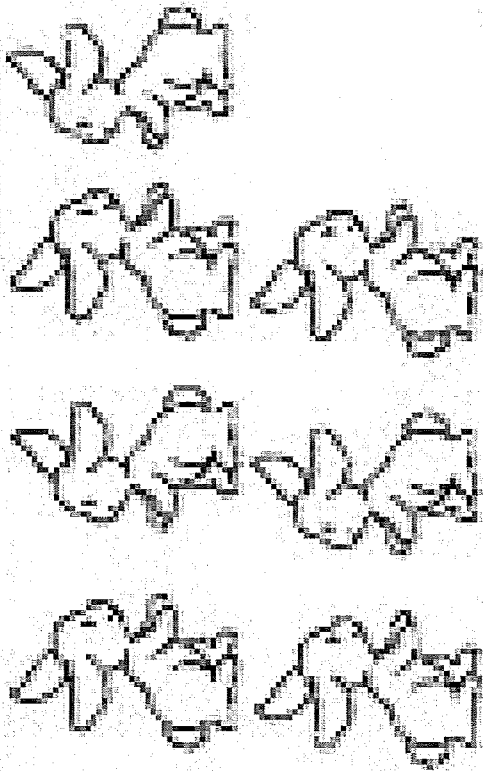

7 CONEJOS

Handwriting practice lines for the number 7. Each line consists of a solid top line, a dashed middle line, and a solid bottom line. The number 7 is printed at the beginning of each line, with a dashed version for tracing. There are four such lines in total.

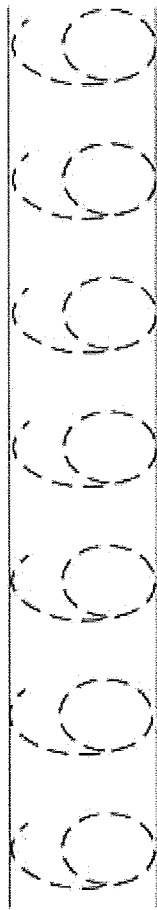
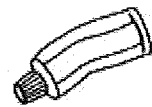
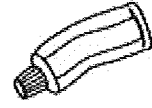
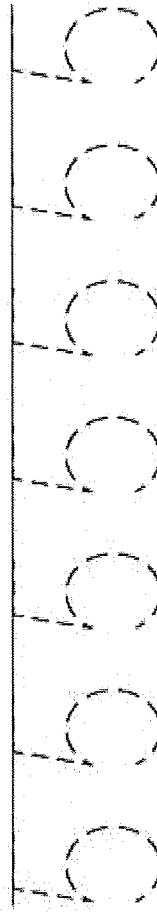
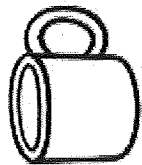
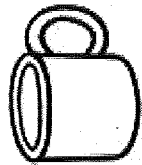
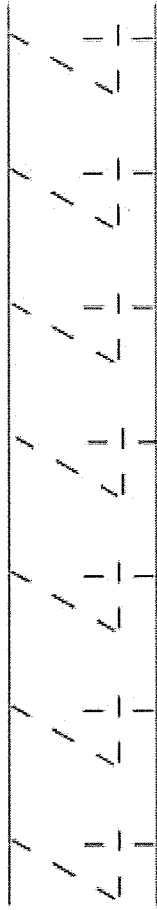
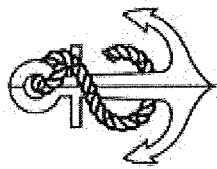
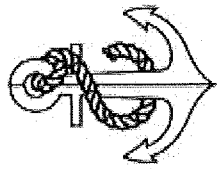
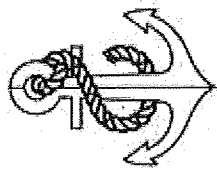
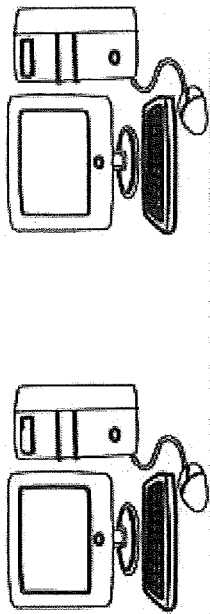
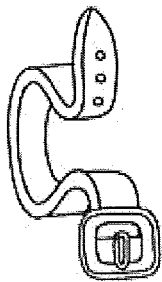

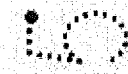
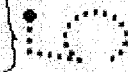
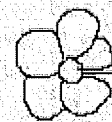
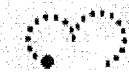
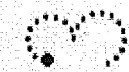
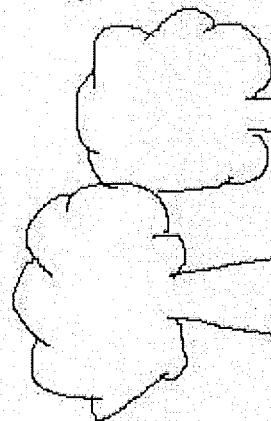
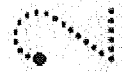
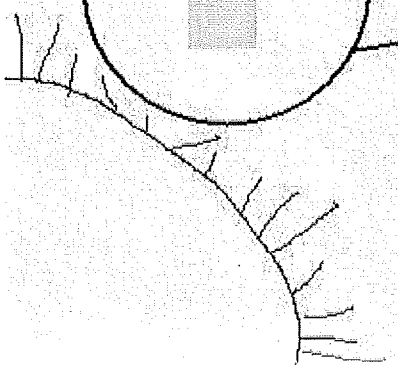
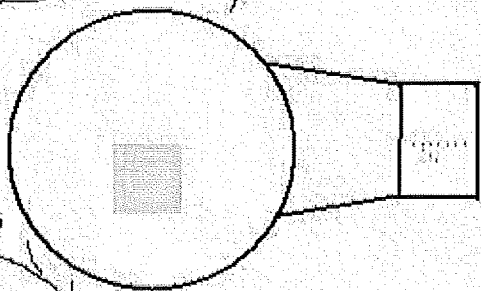
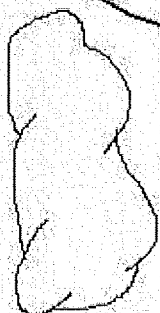
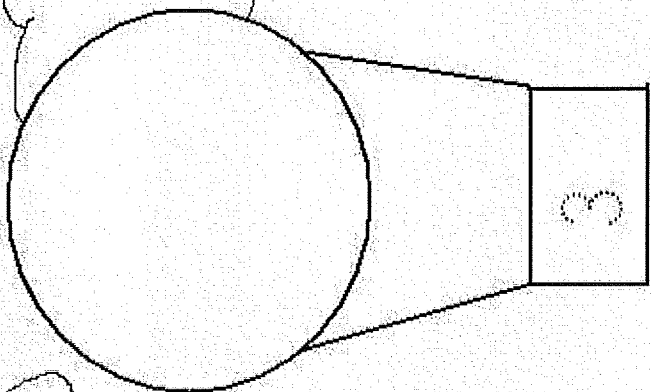
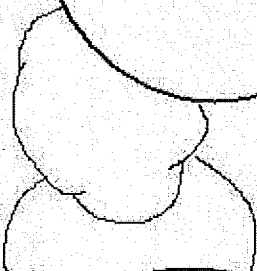
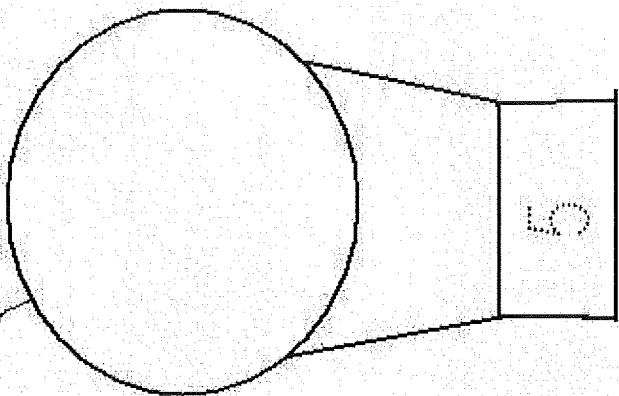
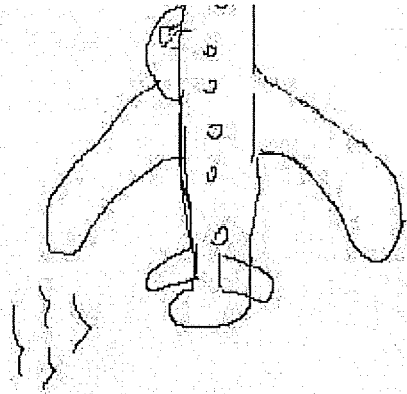
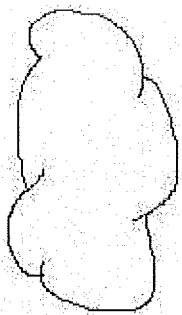



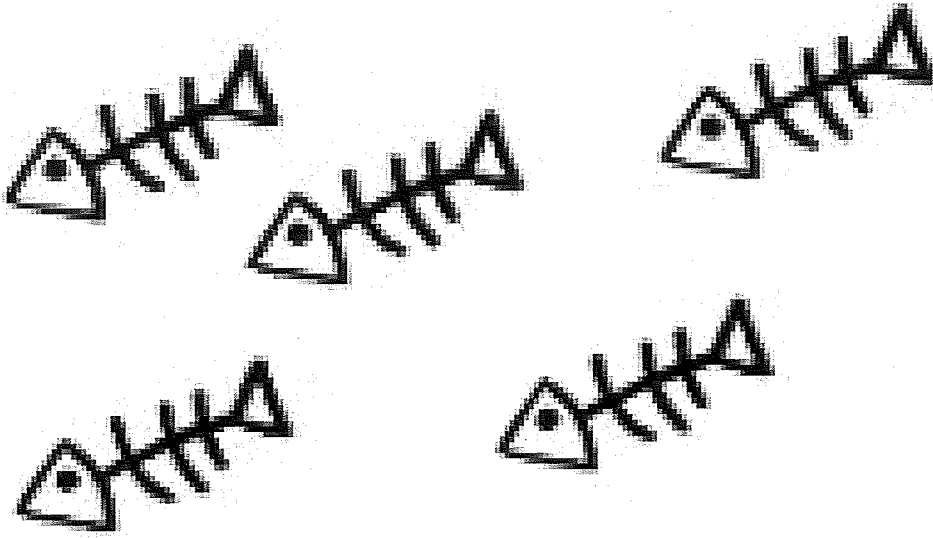



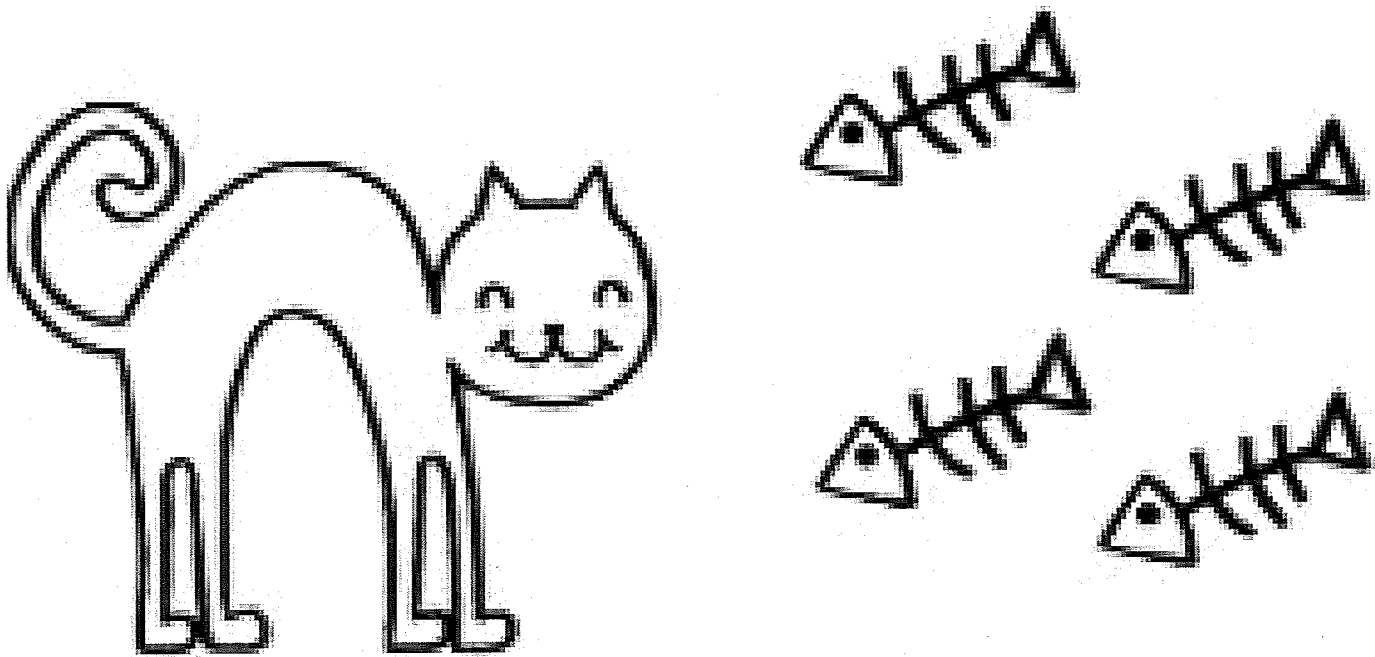



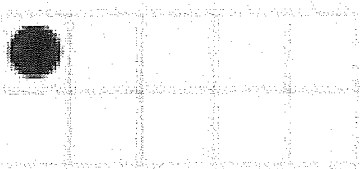
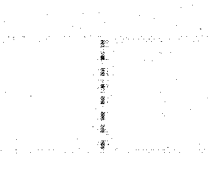
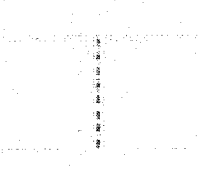
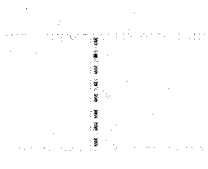
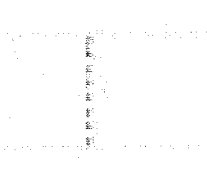
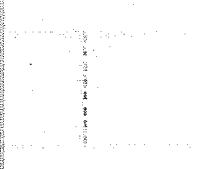
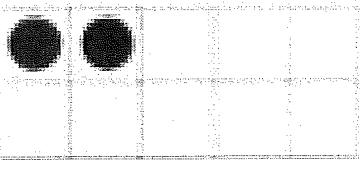

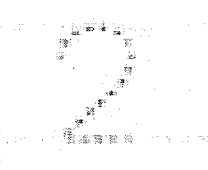

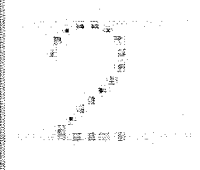
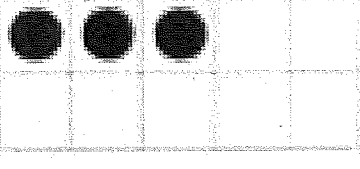



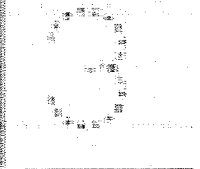
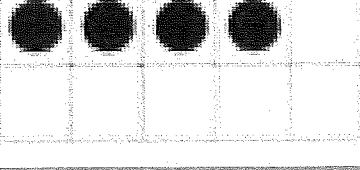
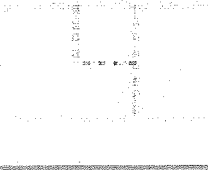
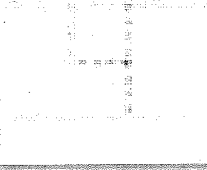
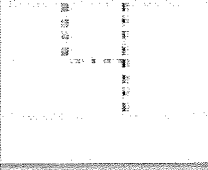
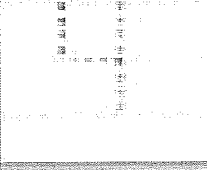

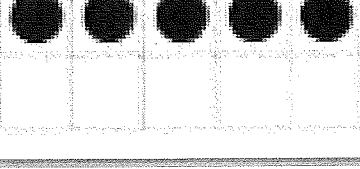

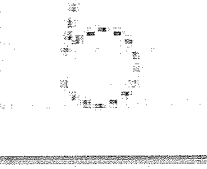
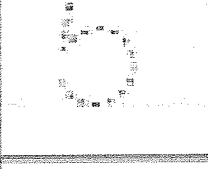
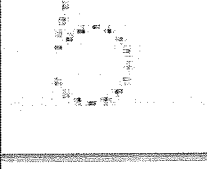
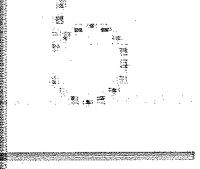
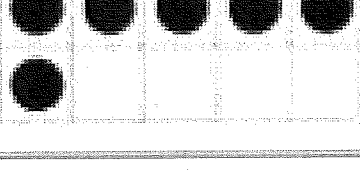
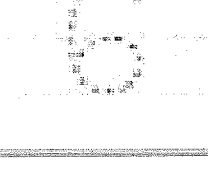
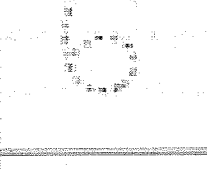
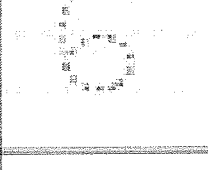
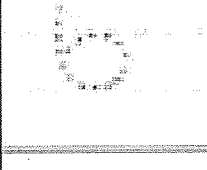
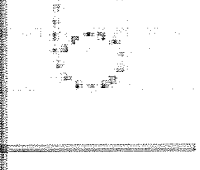
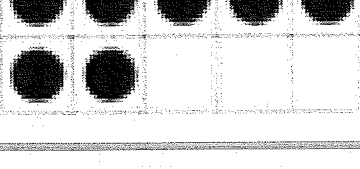
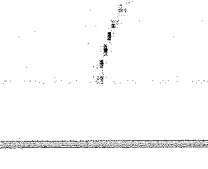
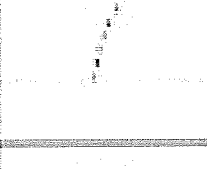
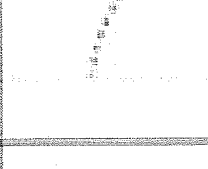
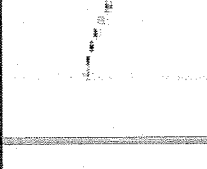
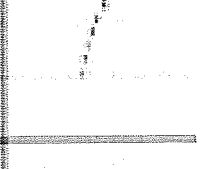
Max, el gatito, ayer comió 5 pescados y hoy se comió 4.
¿Cuántos pescados comió en total?

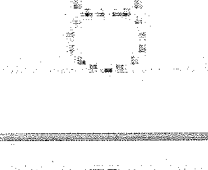
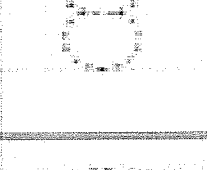
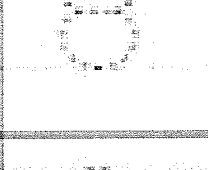
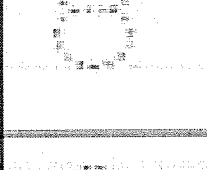
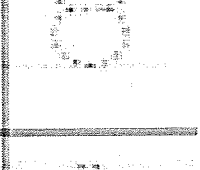

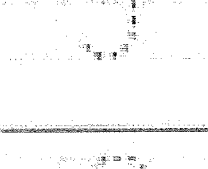
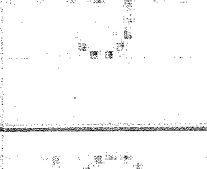
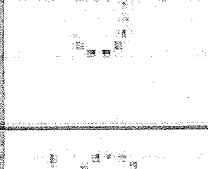
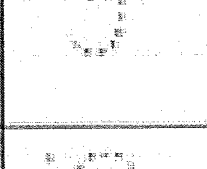
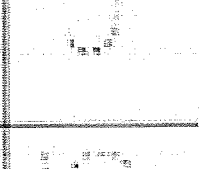
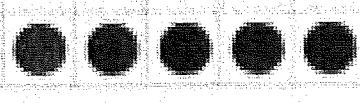

$$\square + \square = \square$$





Anota los números en los cuadros y resuelve la suma



					
					
					
					
					
					
					
					
					
					

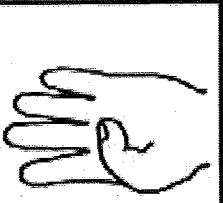

NOMBRE: _____

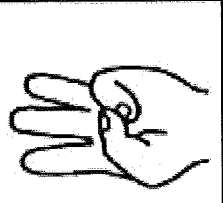

	
<input type="text"/>	<input type="text"/>
+	=
<input type="text"/>	<input type="text"/>

	
<input type="text"/>	<input type="text"/>
+	=
<input type="text"/>	<input type="text"/>

	
<input type="text"/>	<input type="text"/>
+	=
<input type="text"/>	<input type="text"/>

	
<input type="text"/>	<input type="text"/>
+	=
<input type="text"/>	<input type="text"/>

	
<input type="text"/>	<input type="text"/>
+	=
<input type="text"/>	<input type="text"/>

	
<input type="text"/>	<input type="text"/>
+	=
<input type="text"/>	<input type="text"/>



Suma los números y averigua las respuestas

Ya estás listo. Prueba.

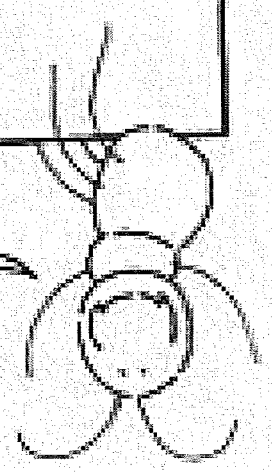

$\begin{array}{r} 3 \\ + 4 \\ \hline \end{array}$	$\begin{array}{r} 1 \\ + 1 \\ \hline \end{array}$
$\begin{array}{r} 1 \\ + 2 \\ \hline \end{array}$	$\begin{array}{r} 4 \\ + 4 \\ \hline \end{array}$
$\begin{array}{r} 3 \\ + 1 \\ \hline \end{array}$	$\begin{array}{r} 2 \\ + 2 \\ \hline \end{array}$
$\begin{array}{r} 2 \\ + 2 \\ \hline \end{array}$	$\begin{array}{r} 2 \\ + 3 \\ \hline \end{array}$

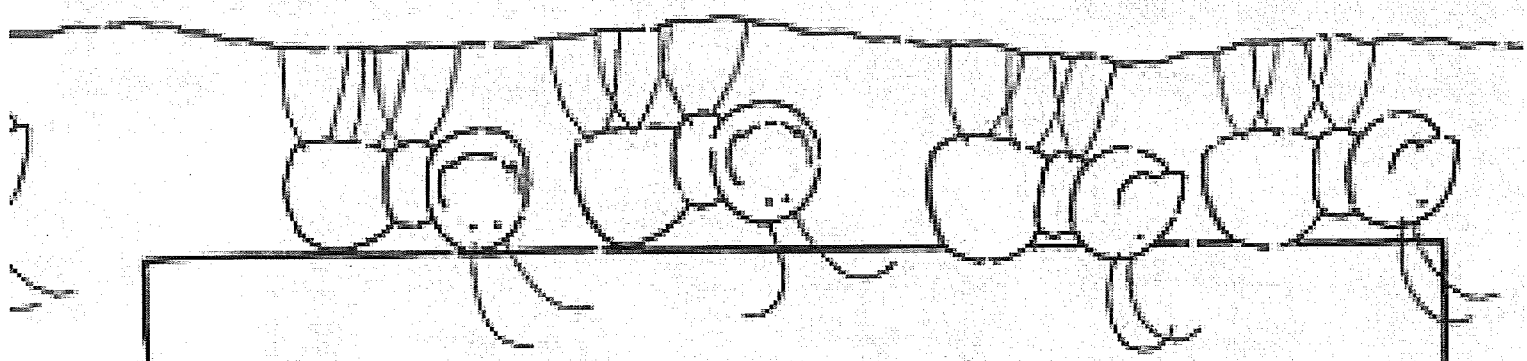

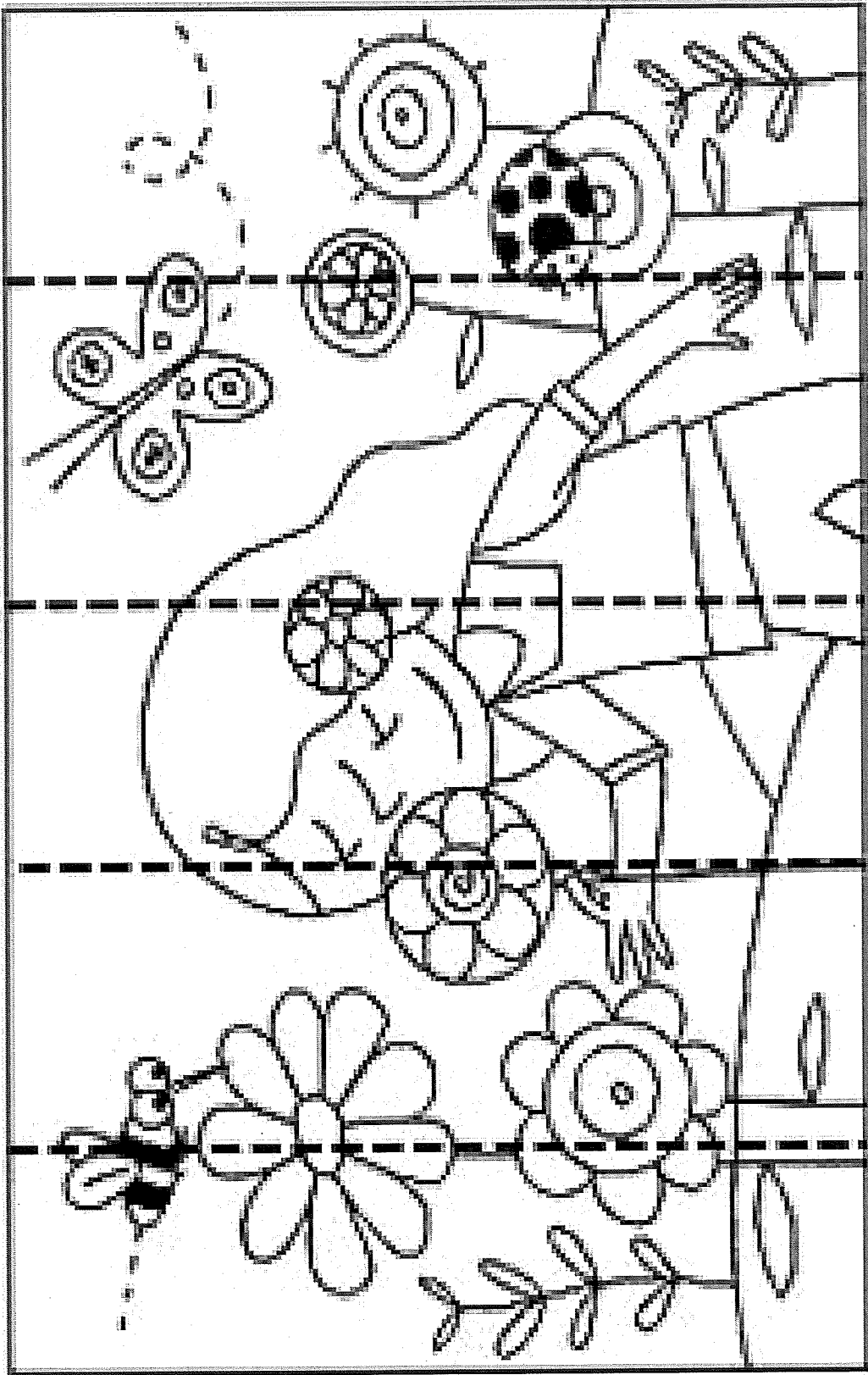

En cada fila hay un dibujo diferente. Pinta de rojo el detalle que lo diferencia.

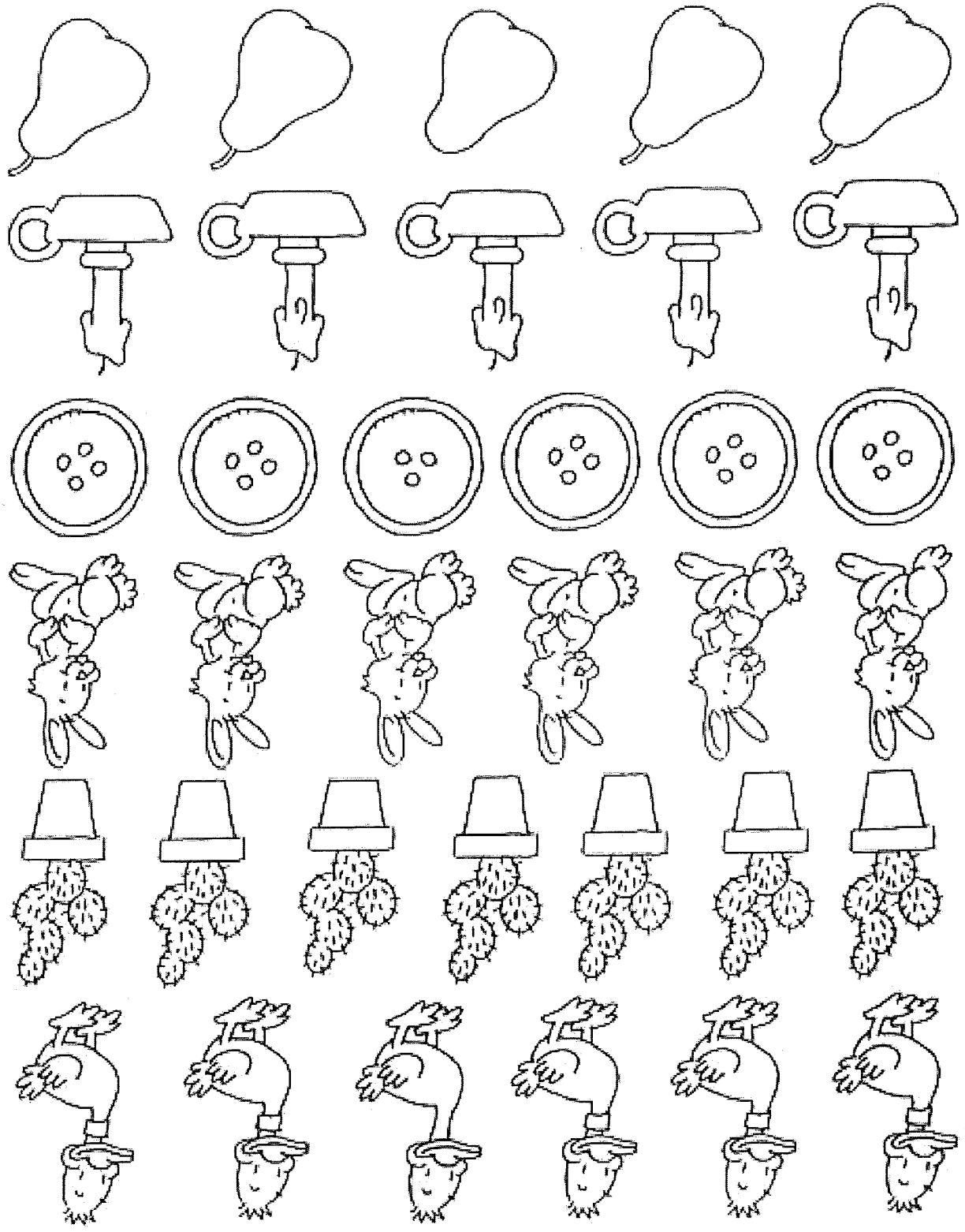

Nombre _____ Fecha _____

!No todos son iguales!

Arriba y abajo

Fecha _____

Nombre _____

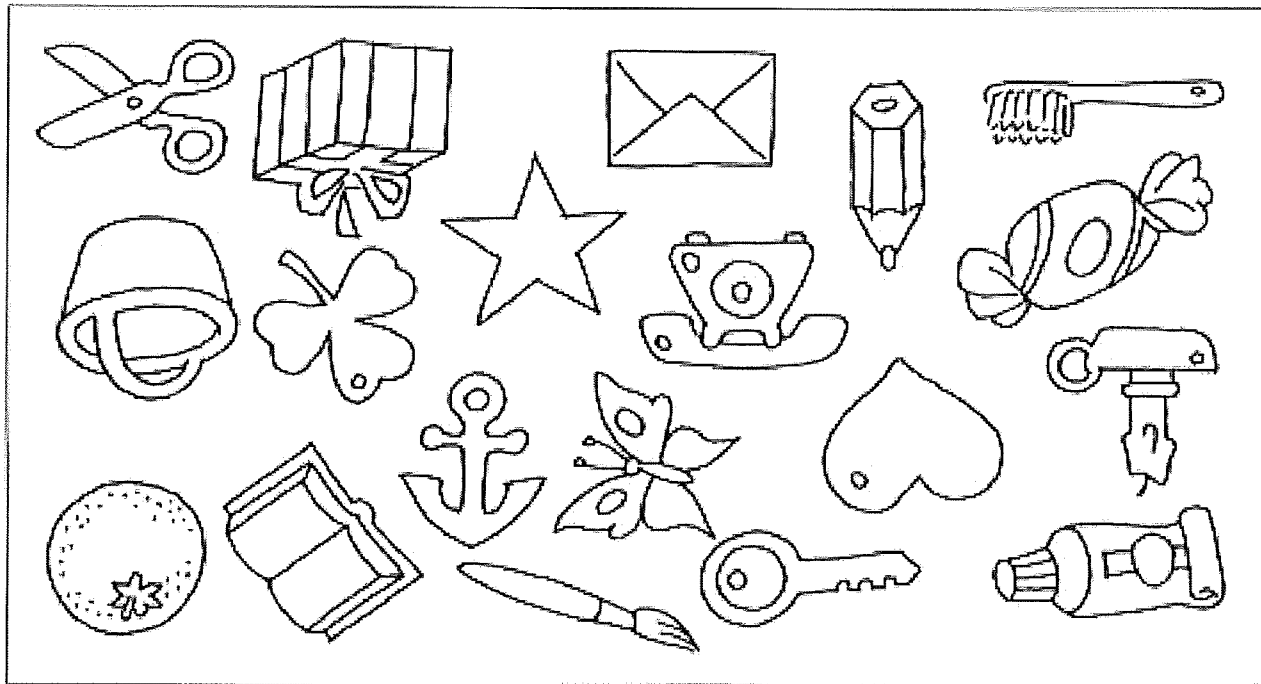
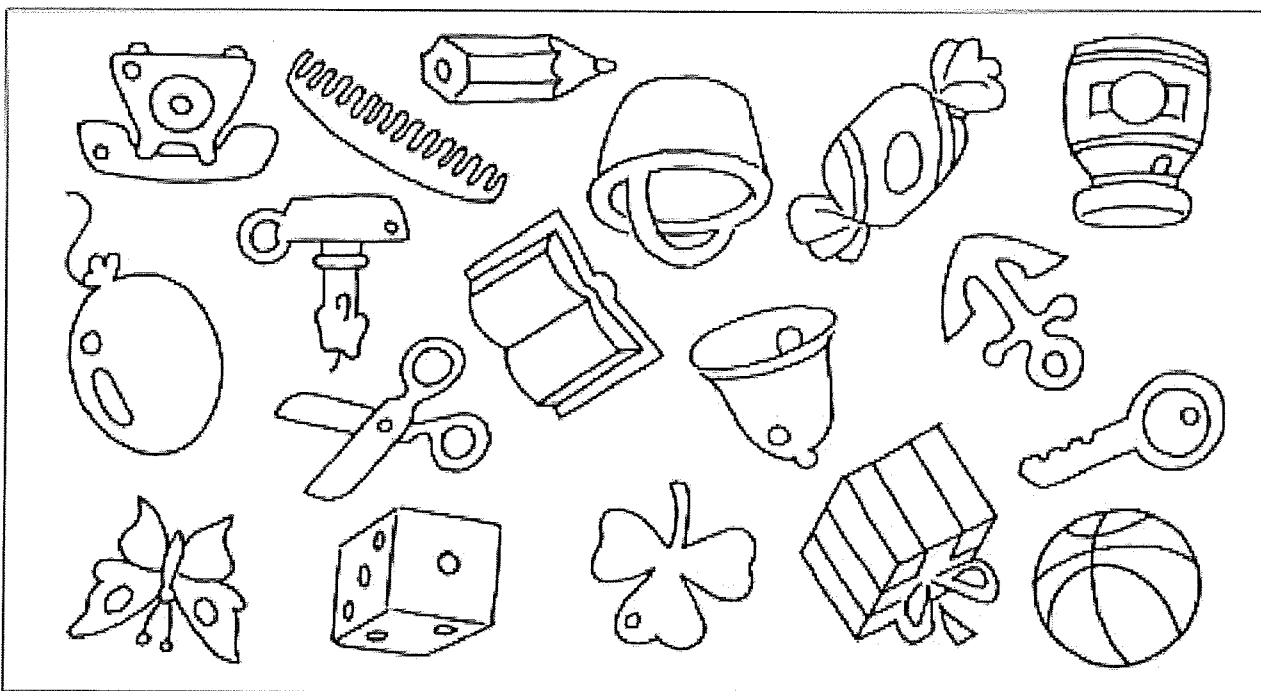

- Pinta de amarillo los objetos del conjunto de arriba que no están en el conjunto de abajo.
- Luego pinta de rojo los objetos del conjunto de abajo que no están en el conjunto de arriba.
- Finalmente, pinta de azul los objetos que están arriba y abajo.